

ISTRUZIONI DI MONTAGGIO E MANUTENZIONE SOFFIONE DOCCIA A SOFFITTO

9926E8

ISTRUZIONI DI MONTAGGIO E MANUTENZIONE

ASSEMBLY AND MAINTENANCE INSTRUCTIONS

INSTRUCTIONS D'INSTALLATION ET D'ENTRETIEN









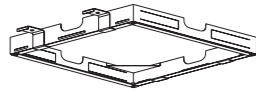
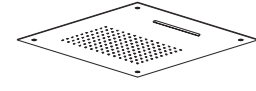
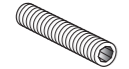

MONTAGE UND WARTUNGSANLEITUNG

INSTRUCCIONES DE MONTAJE Y MANTENIMIENTO

PALLAZZANI

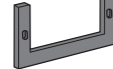
CONTENUTO CONFEZIONE / PACKAGE CONTENTS / CONTENU DE L'EMBALLAGE / PACKUNGSINHALT / CONTENIDO DEL PAQUETE

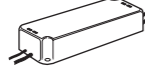
9926E8

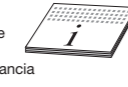
		9926E8
		X1
		X1
		-
		X4
		X2
		X1
		X6
		X1
KIT  		X1
		X1
		X1
IT Istruzioni di montaggio GB Mounting instructions FR Instructions de montage DE Montageanweisungen ES Instrucciones de montaje		X1
IT Istruzioni di montaggio Telecomando GB Remote control mounting instructions FR Instructions de montage télécommande DE Fernsteuerung Montageanweisungen ES Instrucciones de montaje mando a distancia		X1

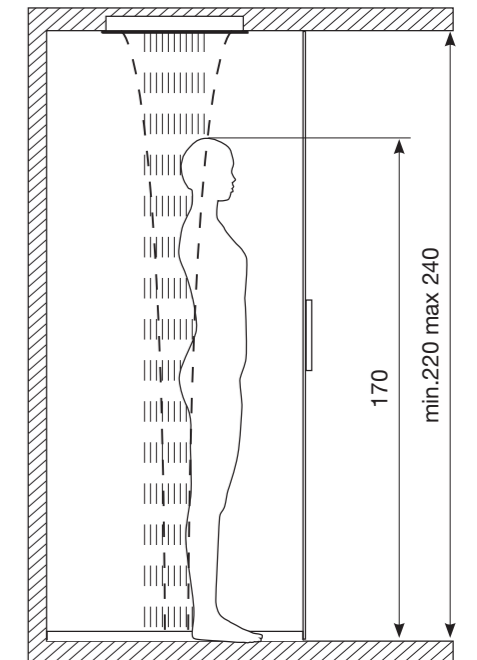
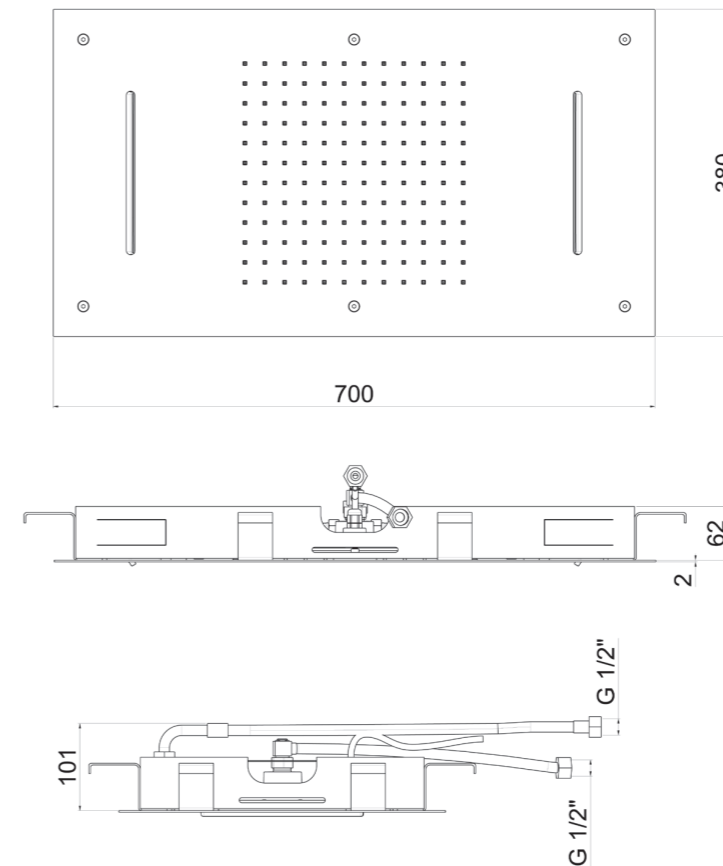

- IT** Telecomando
- GB** Remote control
- FR** Télécommande
- DE** Fernsteuerung
- ES** Mando a distancia

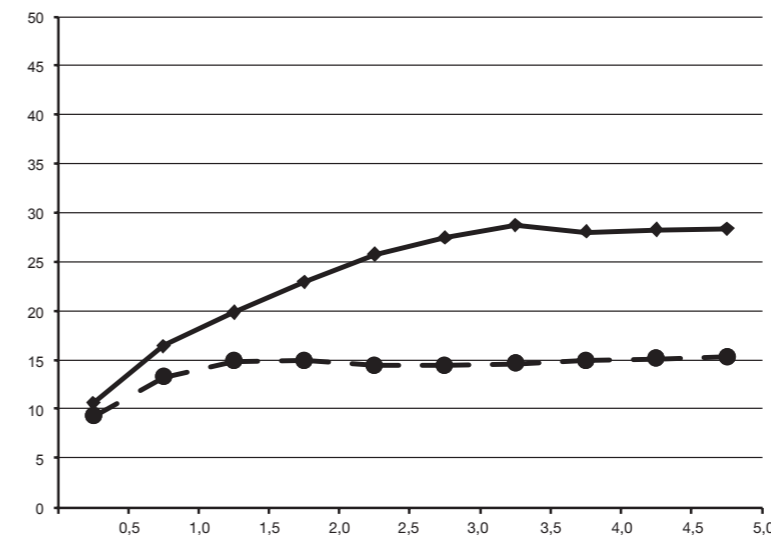

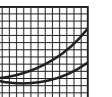

- IT** Portata l/m cascata
 - GB** l/m waterfall flow
 - FR** Débit l/m cascade
 - DE** l/m Wasserfallfluss
 - ES** Caudal l/m cascada
-
- IT** Portata l/m pioggia
 - GB** l/m rain flow
 - FR** Débit l/m pluie
 - DE** l/m Regenfluss
 - ES** Caudal l/m lluvia



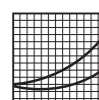

- X2**
- IT** Si consiglia di operare insieme ad un'altra persona
 - GB** We recommend to work with another person
 - FR** Il est fortement recommandé de travailler avec une autre personne.
 - DE** Wir empfehlen mit einer anderen Person zu arbeiten
 - ES** Recomendamos trabajar en conjunto con otra persona

- 
- IT** Diagramma di flusso
 - GB** Flow rate
 - FR** Le débit
 - DE** Flussdiagramm
 - ES** Diagrama de caudal

- 
- IT** Indossare protezioni
 - GB** Wear protection
 - FR** Porter une protection
 - DE** Schütze anziehen
 - ES** Usar protección

- 
- IT** Caratteristiche idrauliche
 - GB** Plumbing specifications
 - FR** Caractéristiques hydrauliques
 - DE** Hydraulische Eigenschaften
 - ES** Características hidráulicas

- 
- IT** Alimentazione elettrica
 - GB** Mains
 - FR** Alimentation électrique
 - DE** Elektrische Strömung
 - ES** Conexión eléctrica

- 
- IT** Pressione d'uso
 - GB** Operating pressure
 - FR** Pression d'utilisation
 - DE** Betriebsdruck
 - ES** Presión de uso

- 
- IT** Temperatura dell'acqua
 - GB** Water temperature
 - FR** Température de l'eau
 - DE** Wassertemperatur
 - ES** Temperatura del agua

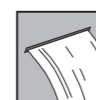
- 
- IT** Litri d'acqua al minuto
 - GB** Liters of water per minute
 - FR** Litres d'eau par minute
 - DE** Liter Wasser pro Minute
 - ES** Litros de agua por minuto

Bar	Pressione Dinamica (bar) / Portata (Litri/min)									
—●—	0,50	1,00	1,50	2,00	2,50	3,00	3,50	4	4,5	5
—●—	10,7	16,5	19,9	23	25,8	27,5	28,8	28,1	28,3	28,4
—●—	9	12,2	13,7	14,2	13,9	13,7	13,9	14,3	14,6	14,3

 MIN 1 Bar
MAX 5 Bar
BEST 3 Bar

 MAX 70° C
BEST 38°/40° C

 **MIN 20 l/m**

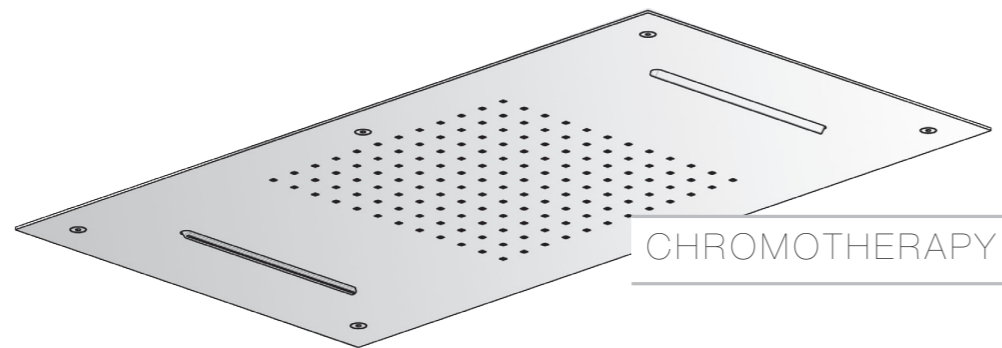

IT L'apparecchio deve essere installato correttamente da personale abilitato ai sensi e per effetto delle leggi in vigore. L'apparecchio non è destinato ad essere usato da persone (bambini compresi) che non hanno ricevuto istruzioni adeguate riguardanti l'uso dell'apparecchio a garantirne la propria sicurezza. I bambini devono essere sorvegliati per sincerarsi che non giochino con l'apparecchio. Prima di qualsiasi operazione togliere sempre la tensione dall'impianto. Predisporre un alimentatore Classe 2 - 12 Vac +/- 3% - Min. 35 VA nella posizione indicata nella figura 1 zona A conforme alle distanze di sicurezza previste dalle normative CEI. Predisporre il telaio di fissaggio e l'uscita dell'impianto elettrico e dell'impianto idraulico come indicato. Installare l'apparecchio seguendo le figure indicate. **Prima di effettuare il collegamento elettrico verificare la tenuta del collegamento idraulico.** La sostituzione dei cavi elettrici se danneggiati e dei pezzi di ricambio deve essere eseguita solo da personale specializzato. Il produttore declina ogni responsabilità per il mancato rispetto del suddetto obbligo.

GB The appliance has to be properly installed by qualified staff pursuant to the current laws. The device is not intended to be used by people (including children) who have not received appropriate instructions regarding the use of the unit to ensure their own safety. Children should be supervised to ensure they do not play with the appliance. Before performing any operation, always unplug the system from the mains. Place a power supplier Class 2 - 12 Vac +/- 3% - Min. 35 VA in the position shown in picture 1 zone A complying with the safety distances provided for by IEC regulations. Arrange the outlet of the wiring and of the plumbing in the shown area. Install the appliance following the shown pictures. **Before connecting the system to the mains, check the tightness of the plumbing.** Replacement of the wiring, when damaged, and of the spare parts has to be performed by qualified personnel only. The producer declines all responsibility in case of non-compliance with the above-said obligation.

FR L'appareil doit être installé correctement par du personnel qualifié au sens et par effet des lois en vigueur. L'appareil n'est pas conçu pour être utilisé par des personnes (enfants y compris) qui n'ont pas reçu une formation adéquate concernant le mode d'emploi de l'appareil, à fin de garantir la propre sécurité. Les enfants doivent être surveillés pour s'assurer qu'ils ne jouent pas avec le dispositif. Avant toute opération toujours mettre l'installation hors tension. Préparer un alimentateur de Classe 2 - 12 Vac +/- 3% - Min. 35 VA dans la position indiquée sur la figure 1 zone A en respectant les distances de sécurité prévues par les normes CEI. Préparer la sortie du circuit électrique et du circuit hydraulique dans la zone indiquée. Installer l'appareil en suivant les figures indiquées. **Avant d'effectuer le raccordement électrique vérifier l'étanchéité du raccordement hydraulique.** Le remplacement des câbles électriques endommagés et des pièces détachées doit être exécuté uniquement par du personnel spécialisé. Le producteur décline toute responsabilité en cas de non respect de la norme sus-décrite.

DE Das Gerät muss korrekt installiert werden und zwar durch Fachpersonal, dass im Sinne der einschlägigen Bestimmungen zugelassen ist. Das Gerät ist nicht dafür bestimmt, durch Personen (einschließlich Kinder), die nicht angemessene Anweisungen hinsichtlich der Benutzung des Gerätes, ihre eigene Sicherheit zu gewährleisten erhalten haben werden. Kinder sollten beaufsichtigt werden, um sicherzustellen, dass sie nicht mit dem Gerät spielen. Vor jedem Eingriff immer Stromversorgung der Anlage abschalten. Das Netzteil Klasse 2 - 12 Vac +/- 3% - Min. 35 VA in der in Abbildung 1 angegebenen Position in Bereich A mit den Sicherheitsabständen gemäß CEI-Bestimmungen (des elektrotechnischen Komitees Italien) vorbereiten. Stromanschlusspunkt und Ausgang der Brauchwasseranlage im angegebenen Bereich vorbereiten. Gerät entsprechend den anliegenden Abbildungen installieren. **Vor dem Anschluss an das Stromnetz prüfen, dass die Wasseranschlüsse dicht sind.** Das Auswechseln beschädigter Elektrokabel und der Ersatzteile darf nur von qualifiziertem Fachpersonal ausgeführt werden. Der Hersteller lehnt jede Haftung ab, wenn diese Vorschrift nicht eingehalten wird.

ES El aparato debe ser instalado correctamente por técnicos cualificados con arreglo a las leyes en vigor. El dispositivo no está destinado a ser utilizado por personas (incluidos niños) que no han recibido las instrucciones adecuadas sobre el uso de la unidad para garantizar su propia seguridad. Los niños deben ser supervisados para asegurarse de que no jueguen con el aparato. Antes de cualquier operación corte siempre la tensión de la instalación eléctrica. Monte un alimentador Clase 2 - 12 Vac +/- 3% - Min. 35 VA en la posición que se indica en la figura 1 zona A de conformidad con las distancias de seguridad impuestas por las normativas CEI. Disponga la salida de la instalación eléctrica y del circuito hidráulico en la zona indicada. Instale el aparato siguiendo las figuras indicadas. **Antes de efectuar la conexión eléctrica verifique la estanqueidad de la conexión hidráulica.** La sustitución de los cables eléctricos, si estuvieran estropeados, y de las piezas de recambio la podrá realizar exclusivamente personal especializado. El productor no se asume responsabilidad alguna en caso de incumplimiento de obligación.

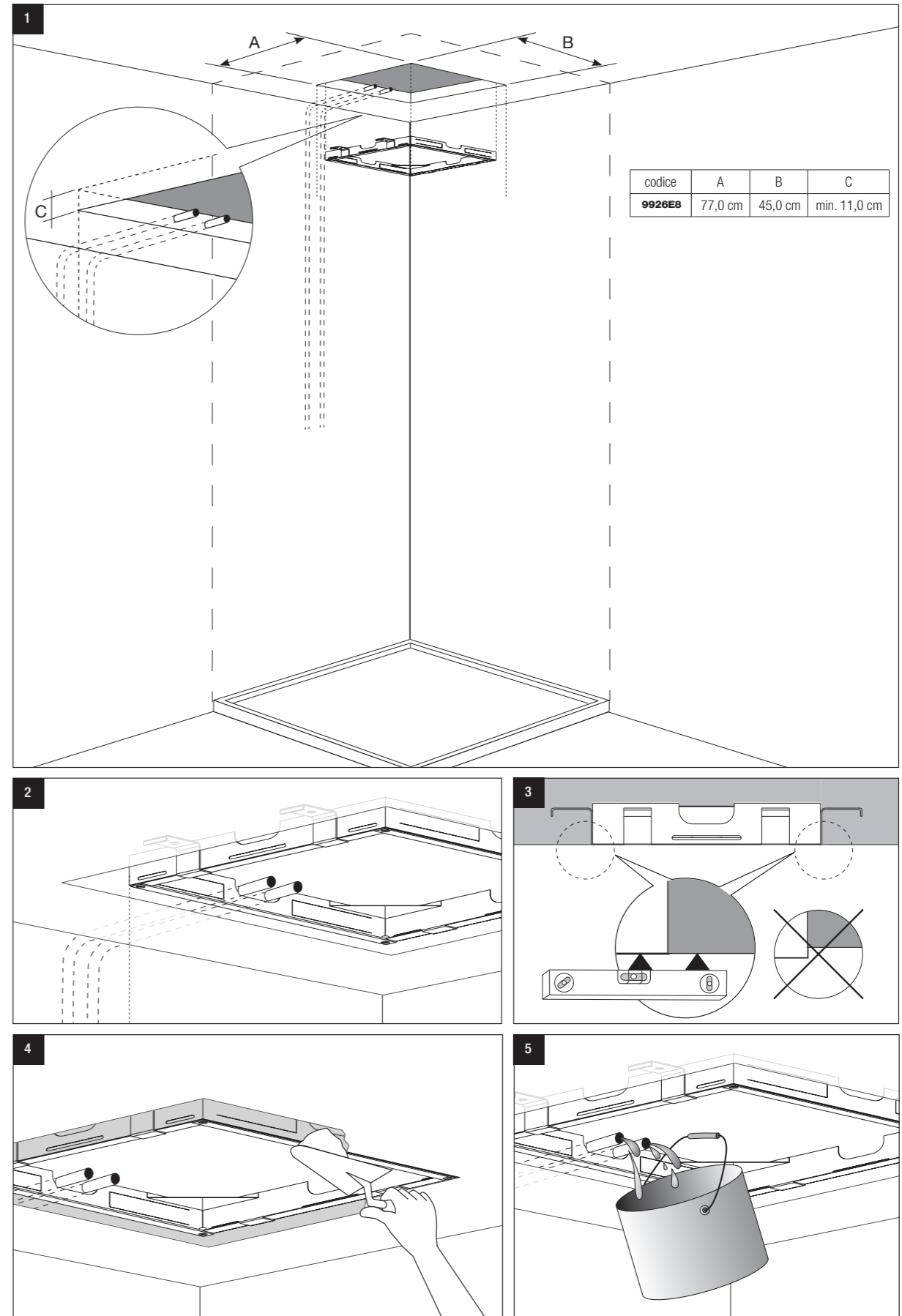

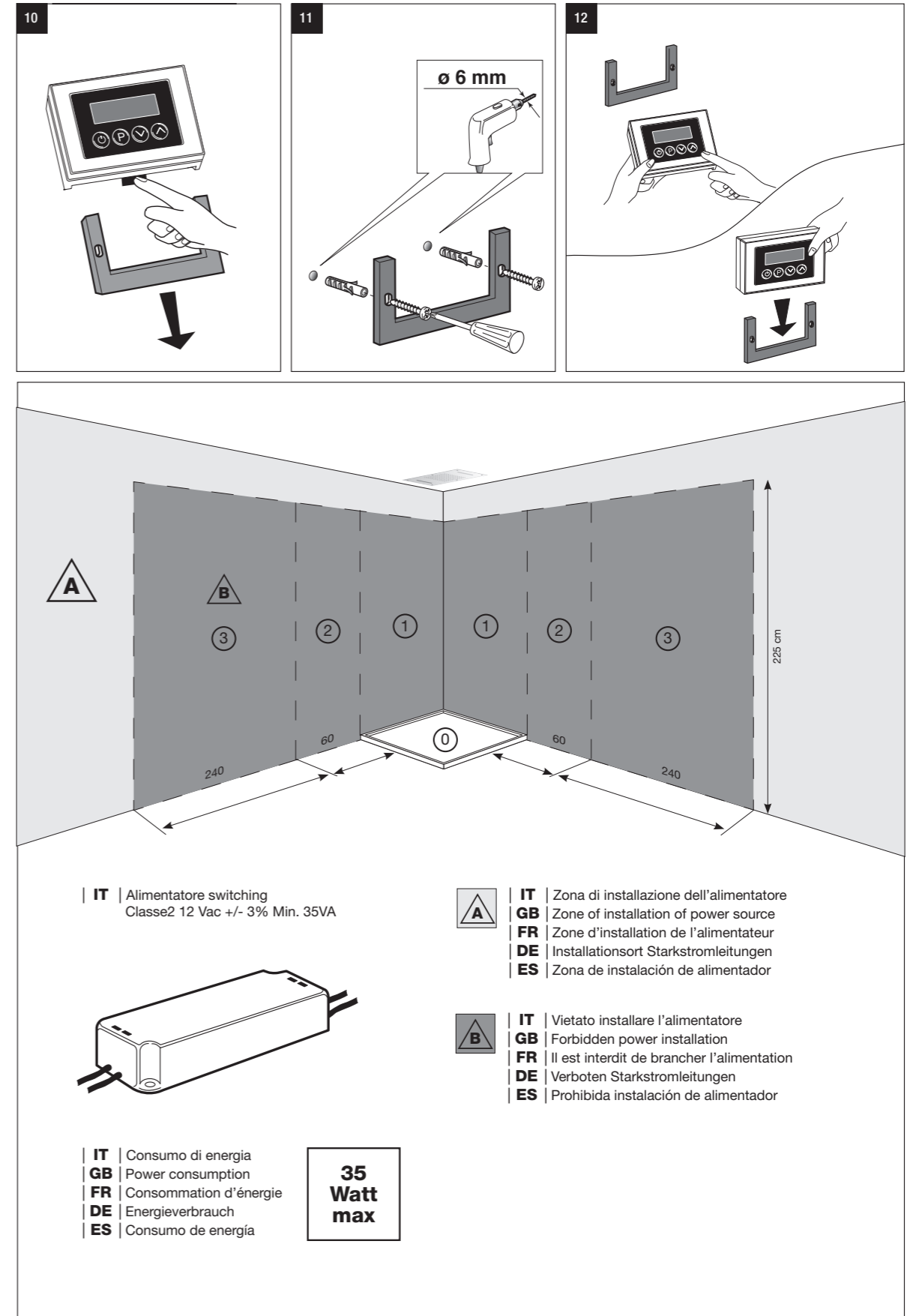
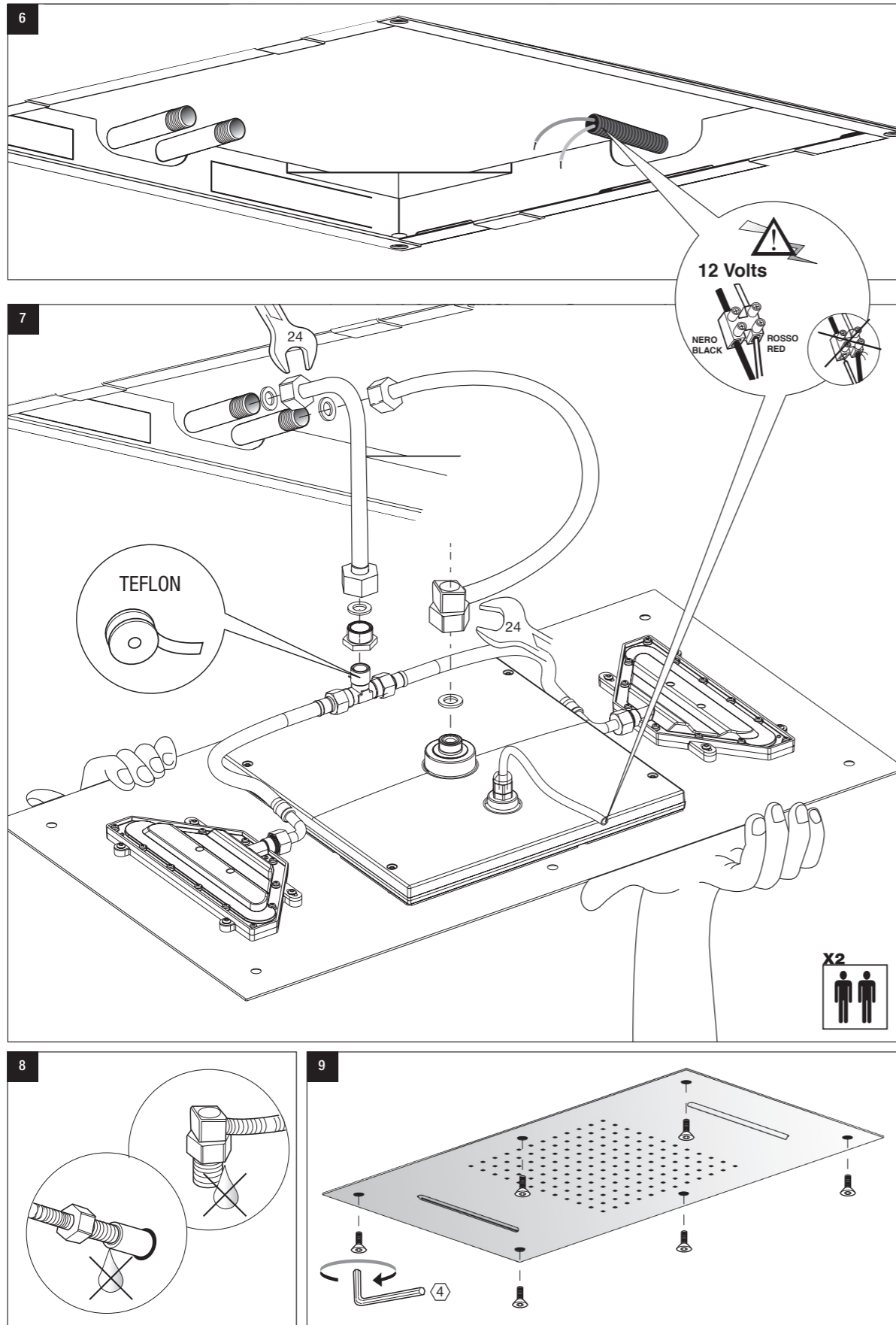

SUGGERIMENTI PER LA PULIZIA / CLEANING TIPS / CONSEILS DE NETTOYAGE / REINIGUNG TIPPS / CONSEJOS DE LIMPIEZA

NOTE

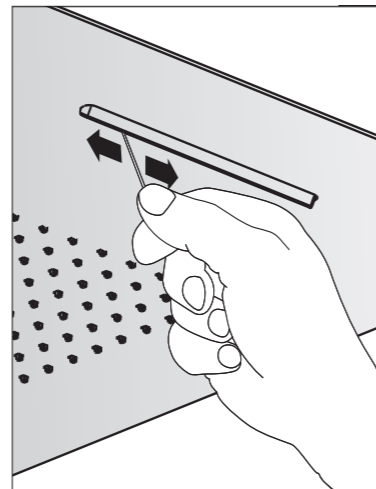
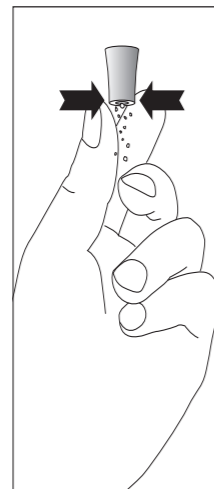
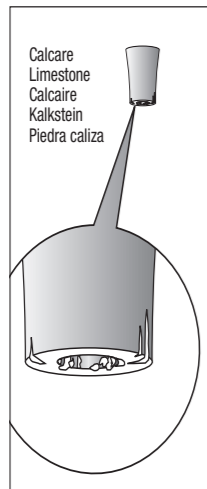
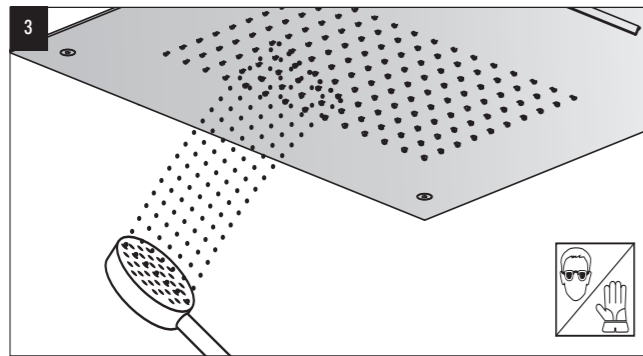
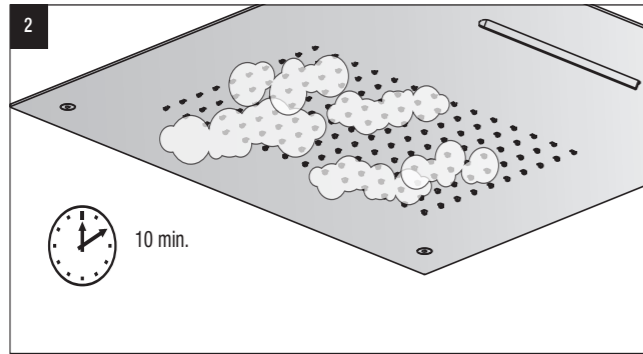
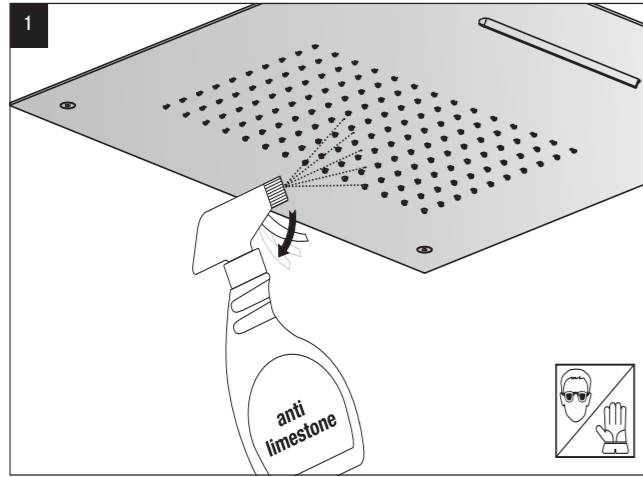



www.palazzani.eu